

WARNING MAY BE INACCURATE

Wiring Diagram

SEE ATTACHED CHARTS FOR WIRING

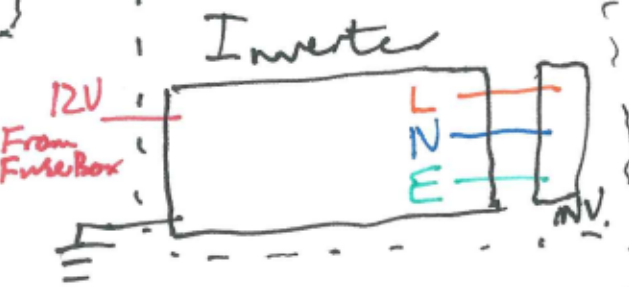
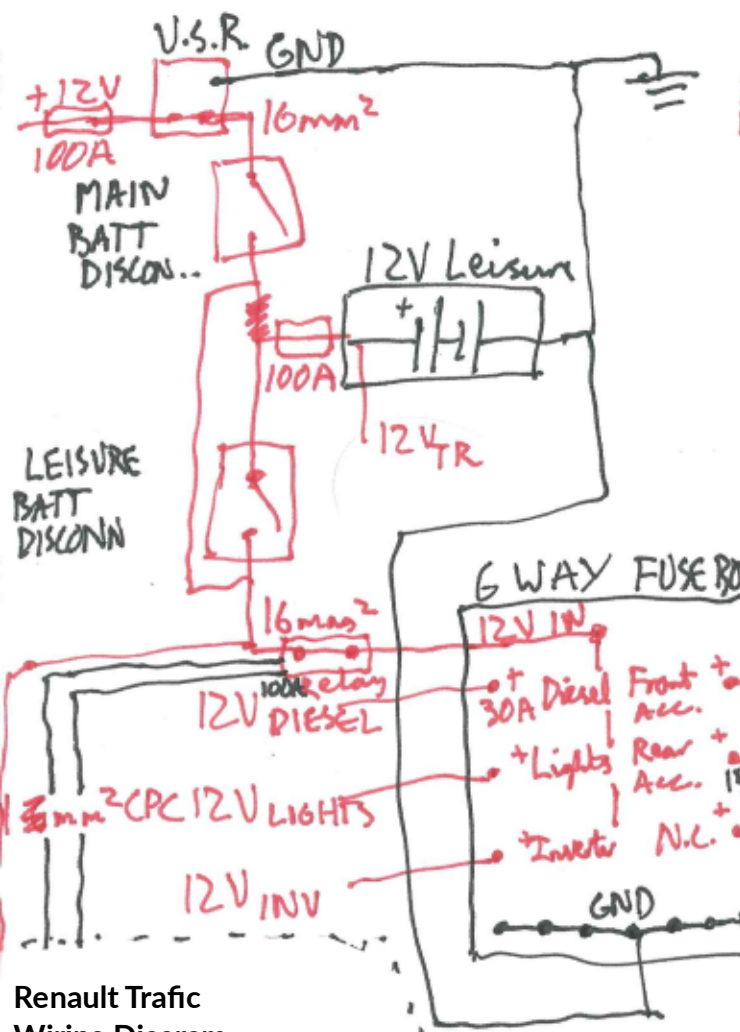

2 Way Transfer

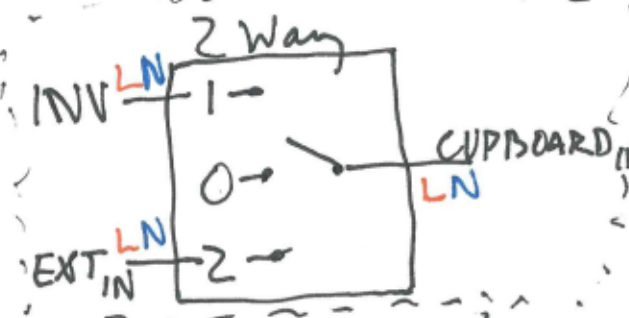
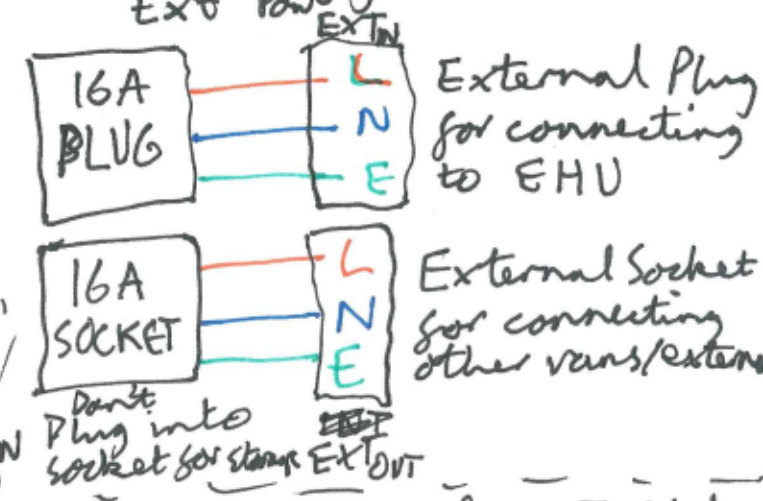

Earth Bus Bar

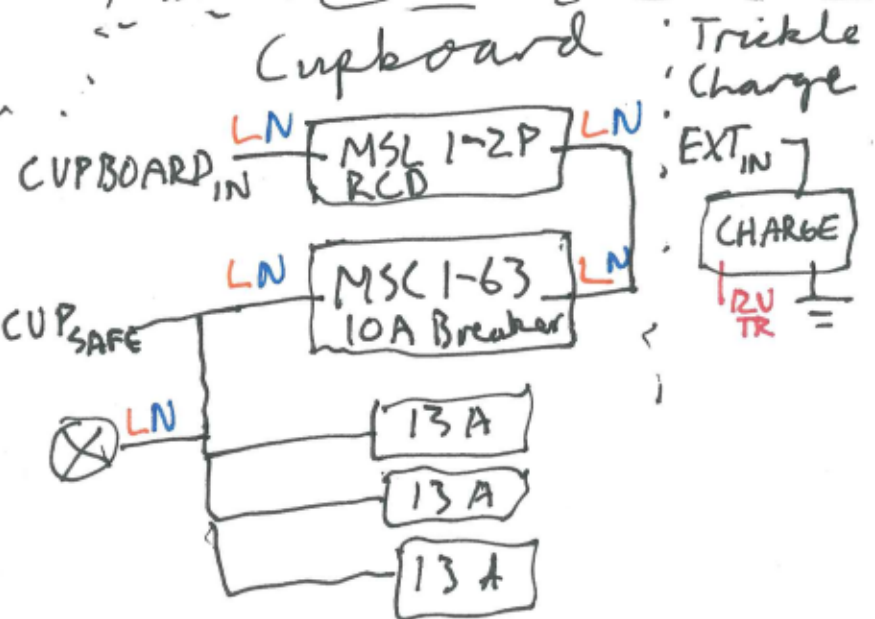
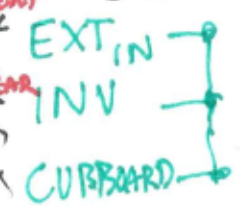

Lights

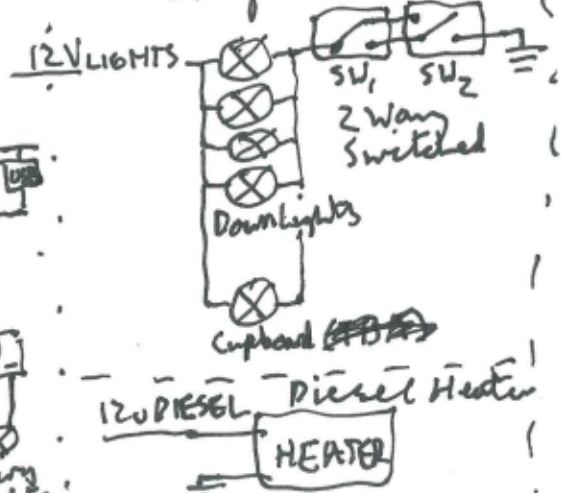

4-way Junction Box

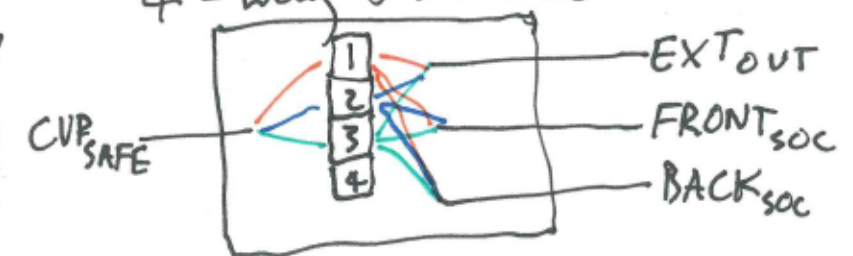

Renault Traffic
Wiring Diagram
Initial Reference
<https://chza.me/traffic-wiring>

Legend:
 ■ Usually +12V DC
 ■ Either GND or label or multi wire
 Live Neutral Earth